



TX90 6kVA & 10kVA Online UPS

6kVA, 10kVA Models

User & Installation Manual

Table of Contents

Safety Instructions And Battery Care.....	4
Safety Instructions.....	4
Battery Care.....	5
Product Introduction.....	6
General Characteristics.....	6
Symbols on the LCD Display Panel.....	8
Panel Explanations.....	10
Communication Port.....	11
Installation And Operation.....	12
Unpacking	12
Selecting Installation Position.....	12
Terminal Block Explanation.....	12
Input Configuration.....	13
Output Configuration.....	14
Start Up in Normal Mode.....	15
Check Measured Values and Figures Detected by the UPS.....	17
Viewing the UPS Default Settings.....	19
Changing the UPS Default Settings.....	21
Troubleshooting Guide.....	24
Troubleshooting.....	24
Communication Software.....	25
Hardware Setup.....	25
Software Installation.....	25
Optional Interface Cards.....	26
Relay (Dry Contact) Card.....	26
SNMP Card.....	26
Interface Card Installation.....	27
Replacing Batteries.....	28

Specifications.....	30
Obtaining Service.....	31
Xtreme Power Conversion Limited Warranty.....	32
Xtreme Power Conversion Load Protection Policy.....	33
Appendix A: T90-EBP920, EBP940, EBP960 User Guide.....	36
Introduction To The Rear Panel.....	37
Installation And Operation.....	38
Selecting Installation Position.....	38
Installation of Casters Cover.....	39
Installation Instructions.....	39
Specifications.....	40

Safety Instructions And Battery Care

Safety Instructions

- For Parallel System installation please refer to TX90 6kVA & 10kVA Parallel System Installation Guide
- Due to small leakage currents generated by the EMI filter in the UPS it is necessary to double check that the ground wire of the UPS is properly grounded before connecting the UPS to the AC mains.
- To ensure safety in all applications where a UPS is hard wired to the electrical supply, ensure that the system is installed by a qualified electrical contractor.
- The UPS has its own internal energy source (battery). Should the battery be switched on when no AC power is available there could be voltage at the output terminals.
- Make sure that the AC utility outlet is correctly grounded.
- Do not open the case as there are no serviceable parts inside. Opening the case voids the warranty.
- Do not try to repair the unit yourself; contact your local supplier. Repairing the unit yourself voids the warranty.
- Please make sure that the input voltage of the UPS matches the supply voltage.
- Use a certified input power cable with the correct plugs and sockets for the appropriate system voltage.
- To prevent any overheating of the UPS keep all ventilation openings free from obstruction, and do not store things on top of the UPS. Keep the UPS 30 cm away from the wall.
- Ensure that the UPS is installed within the proper environmental range. (0-40°C and 0-90% non-condensing humidity)
- Do not install the UPS in direct sunlight. Your warranty may be void if the batteries fail.
- Install the UPS indoors as it is not designed for installation outdoors.
- Dusty, corrosive and salty environments can damage any UPS.
- Install the UPS away from objects that give off excessive heat and areas that are excessively wet.
- If liquids are spilled onto the UPS or foreign objects dropped into the unit the warranty will be null and void.
- The battery will discharge naturally if the system is unused for a long period of time.
- The UPS should be recharged every 2-3 months if unused. If this is not done then the warranty will be null and void. When installed and being used the batteries will be automatically recharged and kept in top condition.
- Do not install the UPS in an environment with sparks, smoke or hazardous gas.
- Make sure the UPS is completely turned off when transporting it. It might cause electrical shock if the output is not cut completely.
- The UPS includes a Maintenance Bypass Switch. Please follow the procedures strictly when switching on or off the Maintenance Bypass Switch.
- The UPS offers a CVCF (Constant Voltage Constant Frequency) setting function.
 1. **For correct setting and wiring please contact with your local utility agent.**
 2. Do not set it yourself or your warranty will be void.
- This UPS has been designed and constructed to protect your assets from the wide range of power aberrations experienced on utility power lines today. It is your insurance for a reliable, clean and stable voltage supply. It is worth taking care to install the system correctly and to have it maintained correctly by your local dealer.
- **SAVE THESE INSTRUCTIONS.** This manual contains important instructions that should be followed during installation and maintenance of the UPS and batteries.
- The UPS is intended for installation in a controlled environment.
- **CAUTION:** A disconnect switch must be provided by others for the AC output circuit. To reduce the risk of fire connect only to a circuit provided with branch circuit over-current protection for 30 amperes for 6kVA (See below for 10 kVA details) rating in accordance with the National Electric Code, ANSI/NFPA 70.

10 kVA tower Output No.	Output rating	Ratings of output branch circuit over-current protection
No.1 (L21-N21)	6 kVA, 120 V	45
No.2 (L22-N22)	6 kVA, 120 V	45
No.3 (L23-N22)	10 kVA, 208 V	50
No.4 (L21-N22)	10 kVA, 240 V	45

- CAUTION: To reduce the risk of fire connect the UPS input to a circuit provided with branch circuit over-current protection for 40A for 6kVA and 60A for 10kVA rating in accordance with the National Electric Code, ANSI/NFPA 70.
- Install the UPS so that it is not likely to be contacted by people.
- The maximum ambient operating temperature is 40°C or equivalent.
- Units are considered acceptable for use in a maximum ambient 40°C.
- Servicing of batteries should be performed or supervised by personnel knowledgeable about batteries and the required precautions.
- When replacing batteries, replace with the same type and number of batteries or battery packs.
- CAUTION – Risk of fire hazard, UPS can be used with four Battery Cabinets.
- CAUTION - RISK OF EXPLOSION IF BATTERY IS REPLACED BY AN INCORRECT TYPE. DISPOSE OF USED BATTERIES ACCORDING TO THE INSTRUCTIONS.
- CAUTION - Do not dispose of batteries in a fire. The batteries may explode.
- CAUTION – Do not open or mutilate batteries. Released electrolyte is harmful to the skin and eyes. It may be toxic.
- CAUTION– A battery can present a risk of electrical shock and high short circuit current. The following precautions should be observed when working on batteries:
 1. Remove watches, rings, or other metal objects.
 2. Use tools with insulated handles.
 3. Wear rubber gloves and boots.
 4. Do not lay tools or metal parts on top of batteries.
 5. Disconnect charging source prior to connecting or disconnecting battery terminals.
 6. Determine if battery is inadvertently grounded. If inadvertently grounded, remove source from ground. Contact with any part of a grounded battery can result in electrical shock. The likelihood of such shock can be reduced if such grounds are removed during installation and maintenance (applicable to equipment and remote battery supplies not having a grounded supply circuit).

Battery Care

If the UPS is unused for an extended period of time it must be stored in a moderate climate. The batteries should be charged for twelve hours every three months by plugging the UPS power cord into a wall receptacle and turning on the input breaker on the front panel. Repeat this procedure every two months under a high-temperature environment.

Product Introduction

General Characteristics





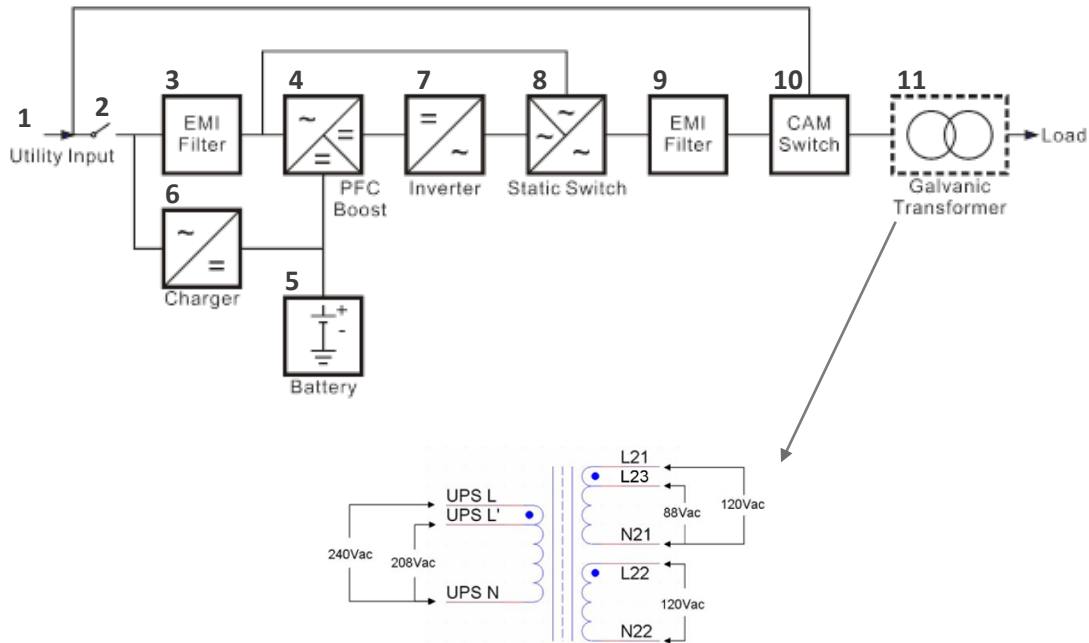







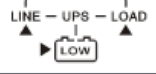

- True online architecture continuously supplies your critical device with stable, regulated, transient-free, pure-sine-wave AC power.
- 20 kHz PWM sine-wave topology yields excellent overall performance. The high crest factor of the inverter handles all high-inrush current loads without a need to upgrade the power rating.
- The multi-functional LCD/LED panel displays various states of the UPS. The LED display shows the UPS working status, utility status and abnormal status. The LCD display shows input/output voltage, frequency, load status, inner cabinet temperature, and abnormal phenomena.
- To protect the unit from overloading, it automatically switches to bypass mode in 160 seconds at 100-105% load, or 40ms if loading is at 105 ~150% of rating. In case of overloading at 150% of rating, it switches to bypass mode immediately. It will automatically switch back to inverter mode once the overload condition ceases.
- Should the output become short-circuited, the UPS cuts the output automatically until the short-circuit situation is removed manually.
- Should the unit become overheated, the internal thermal switch will detect the heat and switch to bypass mode and vice versa.
- The fully digitalized control circuit built into the UPS allows upgrading the functionality of the UPS as well as reaching a high-level of protection of the UPS. Powerful communication capability enhances its ability for remote control and monitoring.
- Maintenance-free, sealed batteries minimize after-sales service.
- The maintenance bypass switch provides an easy and safe troubleshooting or maintenance function when the utility is normal.
- Providing four different working modes (Normal, ECO, CF50 and CF60) it may be used in a wide variety of applications.
- The DC-start function ensures the start-up of the UPS during power outages.
- A revolutionary battery management circuit analyzes battery discharging status to adjust the battery cut-off point and extend battery life.
- The intelligent, temperature-controlled fan may not only extend the life of the fan but also reduce noise because of sudden fan spin. This helps keep your office quiet and comfortable.
- When the UPS is out of order you can read the possible reason directly from the LCD screen, which reduces unnecessary repairs.
- When the UPS is operated in CF50 or CF60 mode, the recommended load connected shall be 75% of rated capacity if the input voltage is 176-280 VAC and 50% of rated capacity if the input voltage is 160-280 VAC.

Single input System Block



1. UPS Utility Input: to provide the AC source to the UPS rectifier circuit and charger.
2. UPS Utility Input Breaker: to protect the UPS Rectifier circuit from over-current.
3. EMI Filter on UPS Utility Input : to eliminate the magnetic interference from AC Source or UPS Utility Input.
4. Rectifier and Booster: When Utility is normal, they will convert the AC to DC and correct input power factor. When Utility is abnormal, the batteries will be boosted to provide the DC voltage to the Inverter.
5. Internal Battery: When AC abnormal, it provides the backup power from the batteries.
6. Charger: the battery charging device.
7. Inverter: To convert the DC voltage to AC voltage
8. Auto Bypass Loop: When the UPS is overloaded or abnormal, the UPS will switch the UPS from inverter output to bypass output automatically.
9. UPS Output EMI Filter: To eliminate the magnetic interference from the UPS Output and avoid the interference caused by the output load and the UPS.
10. Maintenance Bypass Switch: Transfers system to maintenance bypass switch for maintenance.
11. Output isolation transformer with adjustable input taps.

Symbols on the LCD Display Panel

Item	Symbol	Description
1	<i>LINE</i>	Utility or Bypass Source
2		Battery Low
3		Battery Abnormal
4		UPS Overloaded
5		UPS Working in specified mode*
6		A Blackout Transfer occurred in UPS Output.
7		Bypass Input Abnormal, UPS fails to transfer to bypass, Bypass Abnormal at ECO mode
8		Utility Input Abnormal
9	OFF	UPS Shut off
10	LINE OFF	UPS Abnormal Lock
11		UPS Flow Display
12		4-Digit Measurement Display
13		Indicates the item to be measured
14		UPS ON Switch or Alarm Silence
15		UPS OFF Switch
16		Previous Page or Setting Change
17		Next Page
18		Special Function Log In/Out
19		Enter or Reconfirm

20		Utility Input Normal LED
21		Bypass Input Normal LED
22		UPS under Redundancy Mode
23		UPS under ECO Mode
24		UPS Fault or Abnormal Warning LED
25	EPO	Emergency Power Off
26	Er05	Battery Weak or Dead
27	Er06	Output Short Circuit
28	Er10	Inverter Over-current
29	Er11	The UPS is overheated.
30	Er12	UPS Output Overloading
31	Er14	Fan Error
32	Er15	Wrong Procedure to Enter Maintenance Mode
33	Er16	Output Parameters Set Error in Parallel System
34	Er17	ID Numbers are in conflict in Parallel System or ID number error in single unit
35	Er21	Parallel communication error (communication wire disconnected or failure to find ID1 UPS) in Parallel System
36	Er24	CVCF mode with Bypass input
37	Er27	The UPS must be operated in normal mode in Parallel System.
38	Er28	Bypass Overload Time out and cut off output
39	Er31	Control board and driver board settings do not match.
40	Er33	Isolated transformer is overheated.
41	Er**	Other Error code

**The specified modes include Normal mode, ECO mode, CVCF mode, etc.*

Panel Explanations

Front Panel

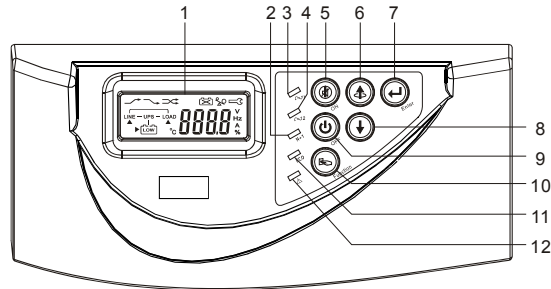

1. LCD
2. Green LED indicates that the UPS is able to run under redundancy mode.
3. Solid green LED indicates that the utility input voltage is within the acceptable window. Flashing green LED indicates that the utility input voltage is outside the acceptable window.
4. Green LED indicates that Bypass Input is normal.
5. UPS ON/Alarm Silence
6. Go to previous page or change the setting of the UPS.
7. Confirm a changed setting.
8. Go to the next page.
9. UPS OFF Switch
10. Special functions log in/out
11. UPS is working under ECO (Economy) mode.
12. UPS Fault or Abnormal

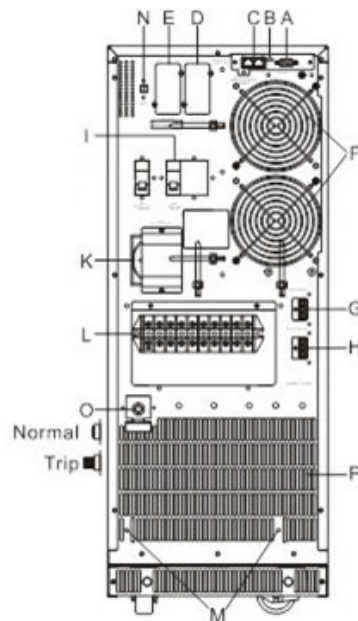

- A. RS-232 Port
- B. Terminal Resistor for Parallel function
- C. CAN Bus Connection Port for Parallel System
- D. Optional Communication Slot 1
- E. Optional Communication Slot 2
- F. Cooling Fans

- G. External Battery Connector
- H. External Charger Connector
- I. Utility Input Breaker CB1
- K. CAM Switch (Maintenance Bypass Switch)
- L. Input/Output Terminal Block (shown with cover removed)
- M. Mounting Holes for External Charger Cabinet
- N. EPO (Emergency Power Off): Short to enable the function
- O. Thermal breaker for the protection of Load in abnormal condition: CB3 (TX90-10K only)
- P. Air Ventilation Hole

Communication Port

The communication port on the UPS provides for RS-232 communication with the UPS software to remotely monitor the power and UPS status.

You may use optional interface cards for Relay (Dry Contact) and SNMP. These cards may be used simultaneously.

The software bundled with the UPS is compatible with many operating systems such as Windows 98, 2000, ME, NT and XP. For other applications such as Novell NetWare, Unix, or Linux please contact your local distributor for a proper solution.

When the optional interface cards are used together with the onboard RS-232 port the EPO signals will get highest priority, then the SNMP/WEB card, then the shutdown command at the relay card, and then finally the onboard RS-232 port gets the lowest priority.

True RS-232

Interface Settings

The RS-232 interface shall be set as follows:

Baud Rate	2400 bps
Data Length	8 bits
Stop Bit	1 bit
Parity	None

Pin Assignments

The Pin Assignments of true RS-232 are as follows (The connector is male):

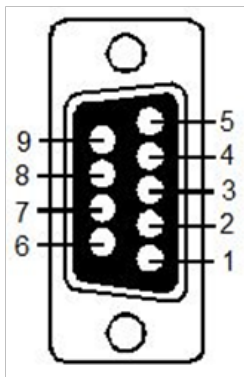

Pin 3: RS-232 Rx
 Pin 2: RS-232 Tx
 Pin 5: Ground

Installation And Operation

Carefully inspect the UPS for shipping damage before installation. Retain the packing material for future use.

Unpacking

Standard package contents:

- Quick start guide
- User manual
- Upsilon 2000 software CD
- (3) Output jumpers
- (4) Small Phillips head screws
- RS-232 cable
- Optional skirt assembly including: (2) 22 3/4" side skirt, (2) 11.5" front and rear skirt, and (1) plastic skirt

Selecting Installation Position

Install the UPS in a proper environment to minimize the possibility of damage to the UPS and to extend the life of the UPS. Please follow these requirements:

1. Keep at least 12 inches clearance from the rear panel of the UPS to the wall.
2. Keep at least 8 inches clearance from the rear panel of the External Battery Pack (EBP) to the wall. Refer to the T90-EBP920, EBP940, EBP960 user manual for more details.
3. Do not block the air flow to the ventilation openings of the unit.
4. Ensure that the installation site is not excessively hot or moist.
5. Do not place the UPS in an environment near dust, corrosive or salty material, or flammable objects.
6. Do not expose the UPS to the outdoors.

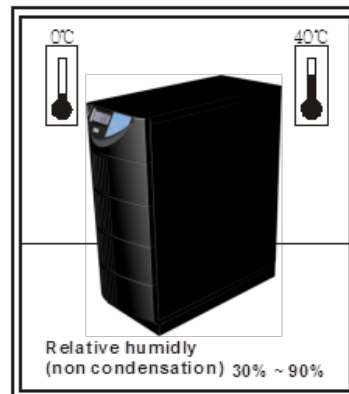
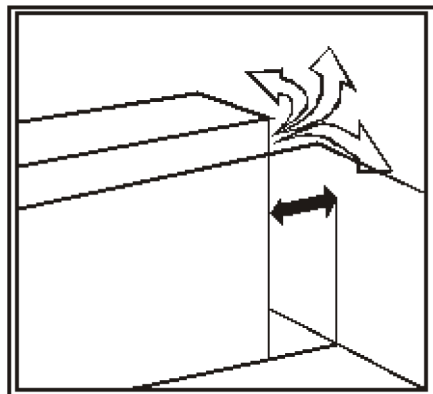

Terminal Block Explanation

TX90-6K & 10K MODELS

OUTPUT						INPUT			
G2	N22	L22	N21	L23	L21	G1	N1	L12	L11
N22, L22, N21, L23, L21: UPS OUTPUT G2 : OUTPUT EARTH GROUND						L12-N1: UTILITY INPUT G1 : INPUT EARTH GROUND			

L11 NOT USED: all systems are single input

N1, L12, G1: the terminals for utility input with single input connection

G1: the terminal for UPS input ground

N1: line 1 (L1) input

L12: line 2 (L2) input

G2, N22, L22, N21, L23, L21: the terminals for UPS output, see below output options for configuration details

G2: the terminal for UPS output ground

Remarks:

1. The maximum current for each terminal is 30 Amps for 6 kVA, 50 Amps for 10 kVA.
2. The UPS is always a Single Input configuration. The Dual Input configuration is not used. The AC source can be 208V or 240V landed to the L12 and N1 terminals.
3. Use No. 6 AWG, 75°C minimum copper wire and 23 lb-in Torque force when connecting to terminal block.
4. The transformer has two input voltage options, 208V and 240V. If the input is configured at 208V but the actual input is 240V, then the output voltages will boost up 15%.

Input Configuration

208V input applications: 208V input with a 120/240V output is the default for these systems. This means the inverter output is programmed to 208V and the output transformer primary tap is set to the 208V setting. These are the default settings for this system. Please refer to output Option 1 in this section.

240V input applications: If the input voltage is 240V, the following steps must be performed to obtain a 120/240V output with a 240V input.

1. With no AC applied to the unit, change the transformer primary tap from 208V default setting to 240V shown below. Access to tap settings is gained by removing the side covers.

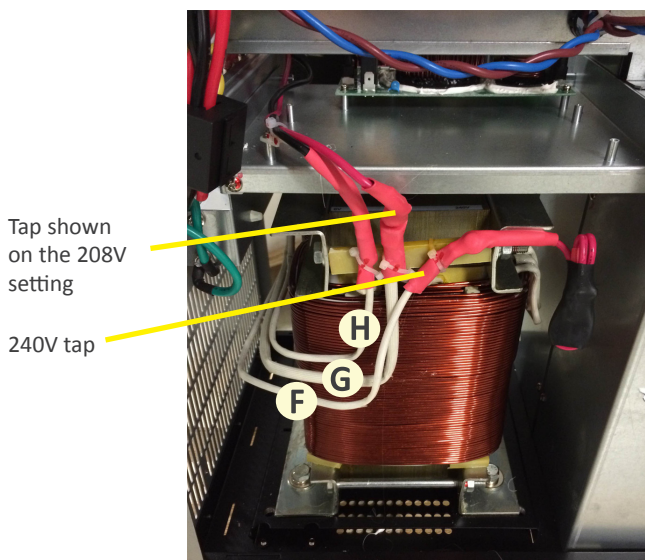

TX90-6K Input Taps

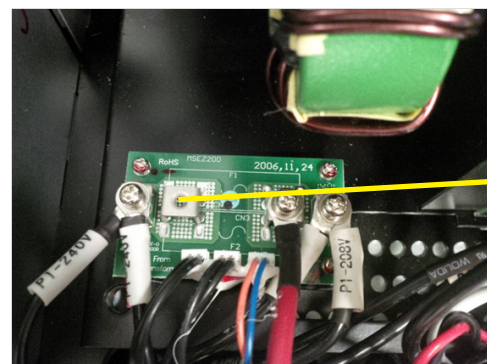

TX90-10K Input Tap Board

2. The UPS inverter output voltage must also be programmed to 240V. Refer to the Changing the UPS Default Settings section for more details. Option 1 below provides a 120/240V output with a 240V input.

Output Configuration

All of the output options shown below apply to 208V input systems and 240V input systems.

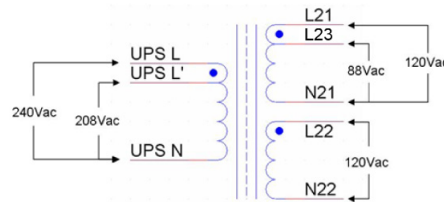

Option 1: 120V/240VAC - THIS IS THE DEFAULT OPTION FOR ALL UNITS: Each branch max loading 50%. Please note the jumpers between G2-L22 and L22-N21 for this option.

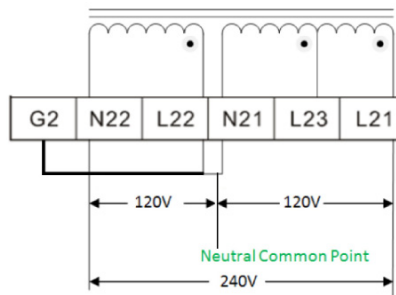

Option 2: 120V full capacity output. Please note the jumpers between G2-N22, N22-N21, and L22-L21 for this option. See below.

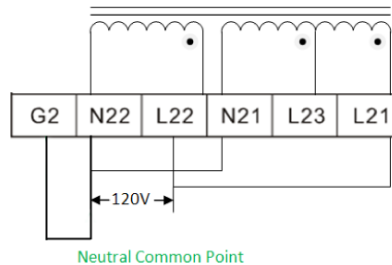

For any other output configurations needed, please contact Xtreme Power Tech Support.

Please refer to the specifications of input current, output current and recommended conductors listed below.

a. AC input and output (minimum 75°C copper wire)

Model	Maximum Input Current	Input Breaker Size	Input & Output Conductor Section	Terminal Torque Force
6KVA	33 A	40 A	AWG #8	17.7/11 lb-in
10KVA	54.3 A	60 A	AWG #6	23 lb-in

b. Battery input

Model	Maximum Current	Conductor Section
6KVA	25 A	AWG #10
10KVA	41 A	AWG #10

Start Up in Normal Mode

- Open the terminal block cover on the rear panel. Before starting the installation make sure the wiring is connected properly.
- Make sure the utility input breaker and the UPS’ input breaker are in the “Off” position.
- Switch on the utility input breaker on the distribution panel and the UPS input breaker. Then the UPS will start up. Green LEDs and show that the Utility and Bypass inputs are normal. UPS will display first figure A1 and then figure B.

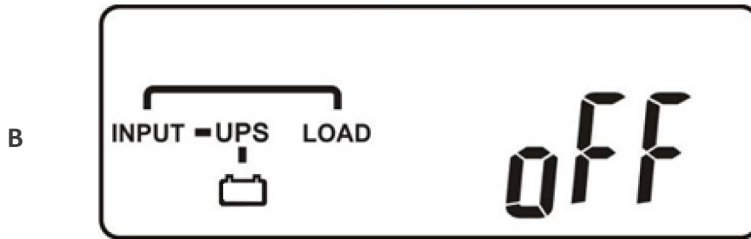
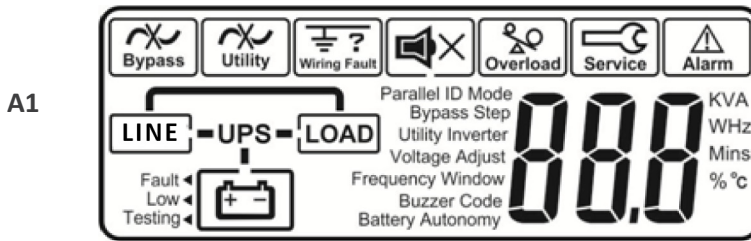

- The UPS is now in Bypass Mode. It will proceed to self-test automatically. If no abnormal message appears then the pre-startup of the UPS was successful and the charger begins to charge the batteries.
- Press the UPS On switch (ⓘ) for approximately three seconds. The Buzzer sounds twice and the LCD display changes from figure B to figure C.

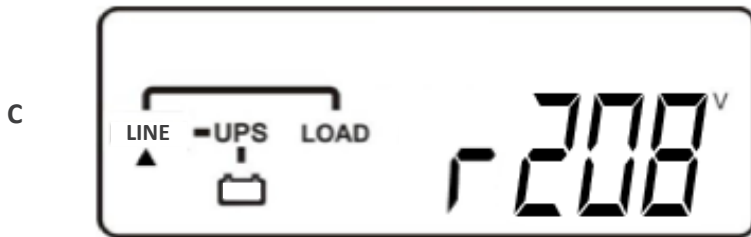

- The UPS is in self-test mode again. The LCD display will change from figure C to figure D, and the UPS will remain in battery mode for approximately four seconds. Then the display will change from figure E1 to figure F if the self-test was successful.

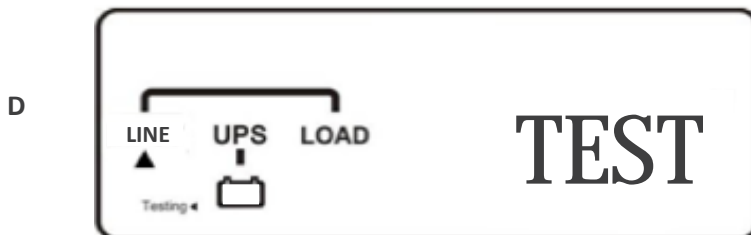

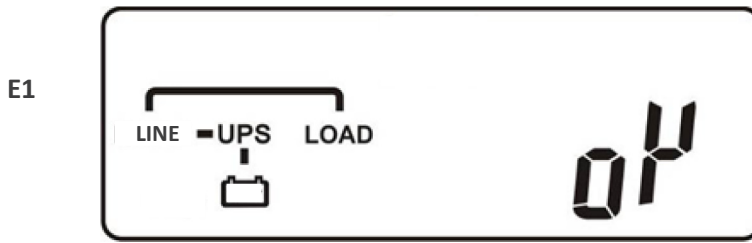

“OK” in self-test

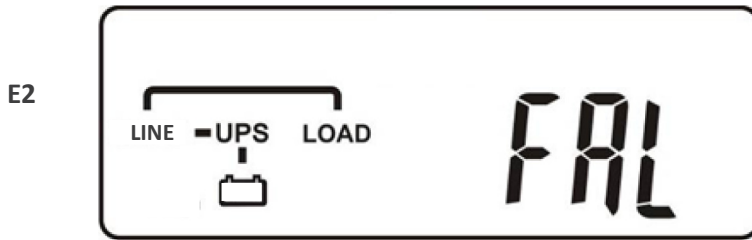

“Fail” in self-test

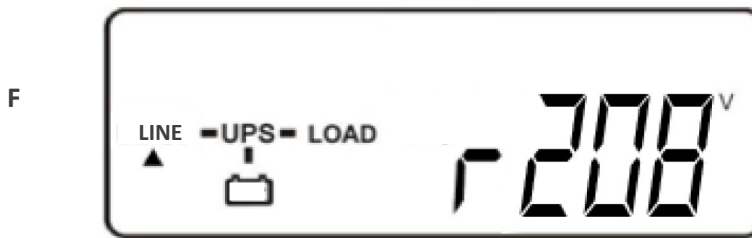

“208 VAC” in Utility Input

- If the self-test fails the LCD display will change from figure D to figure E2. Then an error code or error status will appear on the screen.
- Your start-up operation of the UPS is complete now. Make sure the UPS is connected to utility and charging at least 8 hours and the batteries are fully charged before connecting the device to be protected.

Start-up in Battery Mode (Cold Start)

- Make sure the UPS has at least one string (20 pcs) of batteries.
- Push the UPS On switch (Ⓞ) once for approximately 5 seconds to wake the UPS. The buzzer will sound twice. The LCD display will change from figure A to figure G for approximately 15 seconds.
- Press the UPS On switch (Ⓞ) again for about three seconds until the LCD display changes from figure G to figure H. Then the UPS will be in self-test mode. The UPS may offer energy to the output in a minute, and the LCD displays figure I. In case of failure in pushing the UPS On switch for 15 seconds, the UPS will automatically turn off. You must then repeat steps.

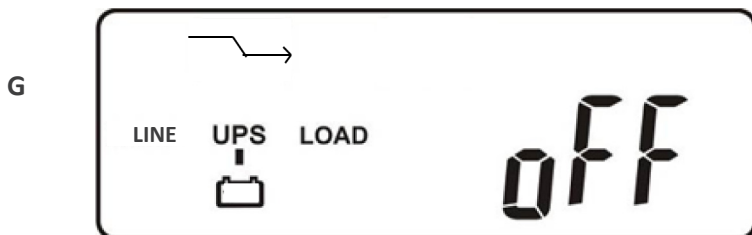

“Off”, which means the UPS pre-start was successful

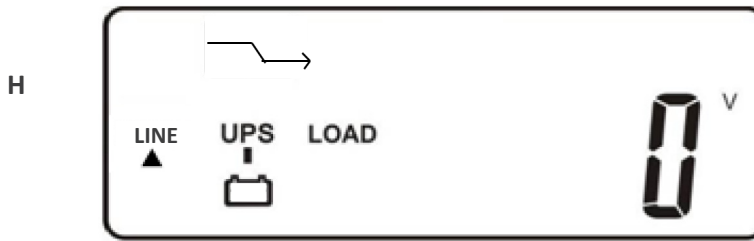

Utility input is "0" and Utility Abnormal.

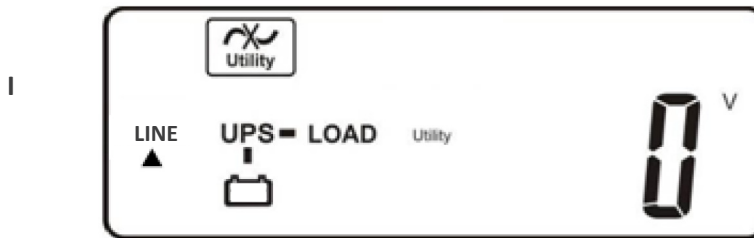

Check Measured Values and Figures Detected by the UPS

- If you would like to check the measured values and figures detected by the UPS, use the scroll up (⬆) and scroll down (⬇) keys. When you scroll down the LCD will display figure C (Voltage from Utility Input) → figure I1 (Voltage from Bypass Input) → figure J (Frequency from Utility Input) → figure K (Frequency from Bypass Input) → figure L (UPS Output Voltage) → figure M (UPS Output Frequency) → figure N (UPS Output Load %) → figure O (UPS Battery Voltage) → figure P (UPS Inner Temperature).

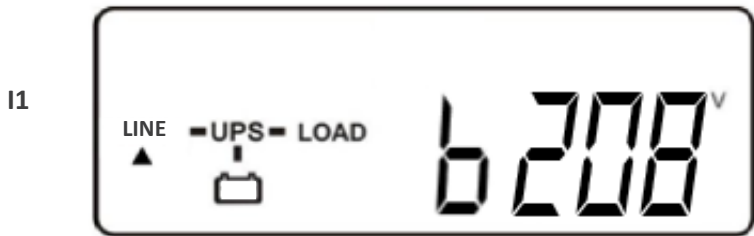

Voltage comes from Bypass Input.

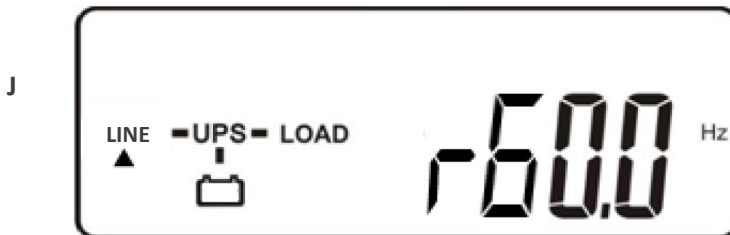

Frequency of Utility Input

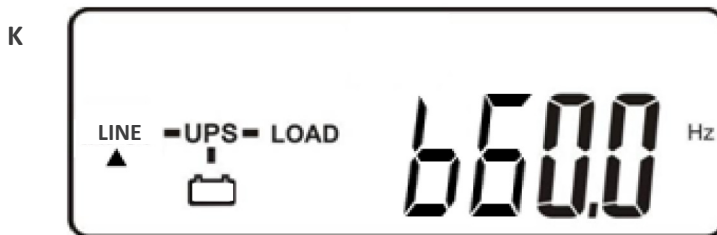

Frequency of Bypass Input

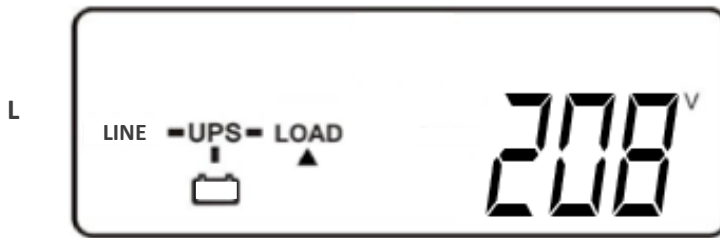

UPS output voltage

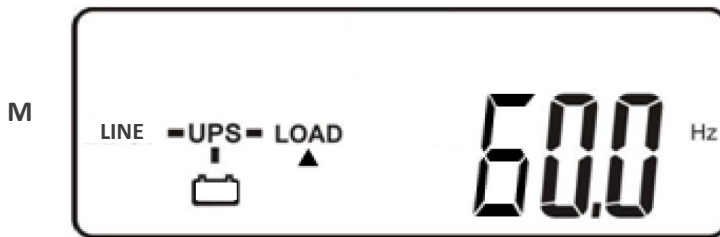

UPS output frequency

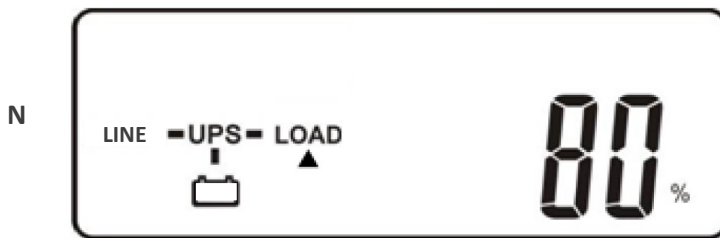

UPS output load level (%)

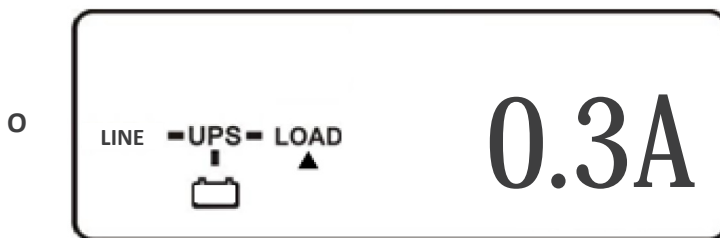

Battery voltage

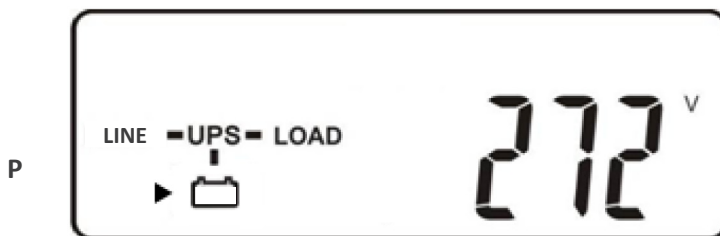

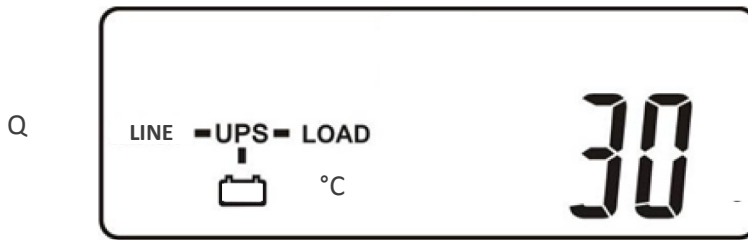

UPS inner temperature

Viewing the UPS Default Settings

- After the UPS completely starts up, press the  (function) key to change the LCD display to figure Q1.



Buzzer "On". Use the  key to toggle the setting and then save.



Buzzer "Off"

- Press the  key to scroll through the UPS settings. The LCD will display in sequence figure Q1 (buzzer) → figure R (Self-test) → figure S (Bypass Voltage Windows) → figure T (Output Frequency Synchronization Window) → figure U (Inverter Output Voltage) → figure V (UPS Operation Mode) → figure W (Output Voltage Micro Tune Value) → figure X (UPS Id) → figure Y (Parallel function status).
- Buzzer and Self-test can only be changed in this mode while the UPS is on. All other settings must be changed while the inverter is off in this mode. See Changing the UPS Default Settings on page 22.
- Default settings shown below.

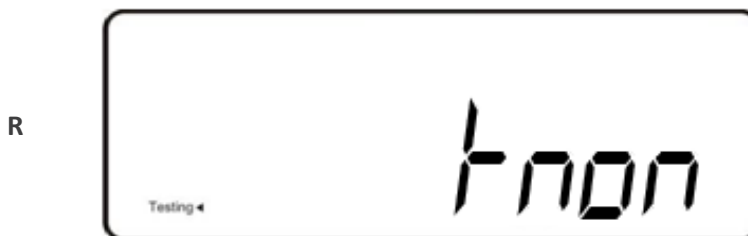

Self-test is not "On". Use the  key to toggle the setting and then save.

Note: Once in this screen, user must arrow down to the cycle through,  changes the settings.

S

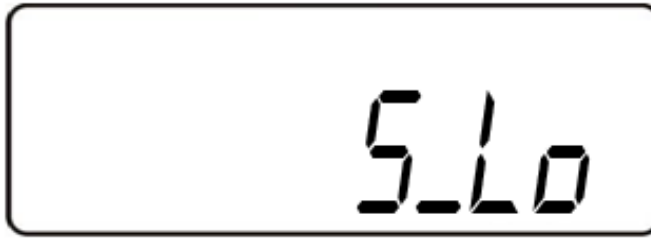

Bypass Voltage is adjusted to narrow range. Selectable to Lo or Hi.

T



Frequency Window is +/-3 Hz. Selectable to ± 1Hz.

U

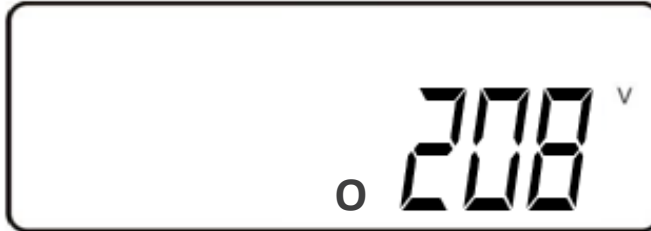

Inverter output voltage set to 208V. Selectable to 200, 208, 220, 230, 240V. This is the voltage sent to the output transformer primary. The UPS output voltages depend on what output configuration is chosen. Please refer to the Output Configuration section of this manual.

V



The UPS is operating in "normal mode". Selectable to ECO, CF50, CF60, and Normal.

W

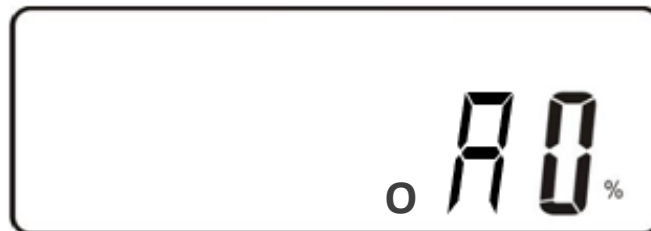

Output Voltage Adjustment (-1, -2, -3, 0, 1, 2, 3%)

X



UPS position in parallel mode





Y



The parallel function is disabled.

- Press the scroll up  key to execute special functions. The functions include buzzer ON (as in figure Q1), buzzer OFF (as in figure Q2, Alarm silence for UPS Warning), and self-test OFF (as in figure R). The UPS will execute the battery test for ten seconds. If the self-test is successful it will display figure E1; otherwise, it will display figure E2 and an error message at the same time.)

Changing the UPS Default Settings

- Make sure the UPS is not “On”. Press the On  and scroll down  keys simultaneously for approximately three seconds. The buzzer will sound twice, and the LCD will display figure Q1, indicating that the UPS is in setting mode.
- Except for Buzzer (figures Q1 and Q2) and Self-test (figure R) all of the other default settings may be changed by pressing the scroll up  key.
- Figure S indicates the bypass input acceptable window. It can be 184-260 VAC or 195-260 VAC.
- Figure T indicates the bypass frequency window of the Inverter Output. The acceptable setting values are ± 3 Hz and ± 1 Hz.
- Figure U indicates the acceptable Inverter Output Voltage. Possible values are 200, 208, 220, 230, or 240 VAC. **The inverter output voltage needs to match the input voltage for this system.**
- Figure V indicates the operation modes of the UPS. Possible values are Online, Eco (Economy) mode, fixed 50 Hz Output, and fixed 60 Hz Output.
- Figure X indicates the adjustment of the Inverter Output voltage, which may be set to 0%, +1%, -1%, +2%, -2%, +3%, or -3%.
- Figure Y indicates the position of the UPS when the UPS is in Parallel mode. Possible positions are 1, 2, 3, and 4. The position must be 1 if the UPS is not in Parallel mode.
- Figure Z indicates the parallel function status. “P 01” indicates that the parallel function is disabled, and “P 02” indicates that the parallel function is enabled.
- After changing settings you must scroll to the “SAVE” screen (figure Z) and then press the enter  key to save all of your changes. Then the LCD will display figure AA to indicate completion of the setting changes. To cancel your changes rather than save them press and hold the “OFF” key  for five seconds. The LCD displays figure AA directly, which indicates that your changes were canceled.







Press the Enter key to save changes.



The UPS is locked.

- Turn Off the Utility Input Breaker
- Your setting changes are now complete.
- Restart the UPS

Troubleshooting when the UPS is Off Due to Unknown Reasons

- If there is a serious abnormal condition the UPS will lock itself in the “OFF” position as shown in figure AA, and an “abnormal” message will appear on the LCD.
- After three seconds all messages will be locked except Bypass messages (LED  and LCD ). If the Utility is abnormal after the UPS is locked the LED  will be extinguished and the LCD  will appear on the LCD.
- To release the UPS lock proceed as follows:
 1. Check the recorded error messages.
 2. Check the error messages in the Troubleshooting guide to help troubleshoot the problem. For further help consult your local distributor.
 3. Press the Off  key for five seconds. A buzzer will sound twice.
 4. Turn Off the Utility Input breaker.
 5. Even if the UPS lock problem is solved now, consult with your local distributor to make sure that the error condition is resolved.

Shut Off

1. Press the Off  key for five seconds. The Inverter output will be turned off, and the output load will be supplied by the Bypass loop. The LCD will display figure B.
2. Turn Off the Utility and Bypass Input breakers.
3. The UPS is now turned off completely.

Maintenance Bypass Mode

1. Maintenance Bypass Mode is for UPS maintenance only. Only authorized technicians are allowed to perform the following procedures. If there is any damage during unauthorized execution of these procedures your warranty will be void immediately.
2. Press the Off  key for approximately five seconds. The LCD will display figure B, and the UPS output will be in bypass mode.
3. Remove the cover of the CAM Switch (Maintenance Bypass Switch), then turn on the CAM Switch to

"Bypass" mode. In the upper right-hand corner of the LCD a  sign will appear.

4. Turn off the UPS Utility breaker. You may proceed with UPS maintenance now.
5. When you are done with UPS maintenance put the UPS back into normal working mode as explained previously. Then return the CAM switch to "INV" mode, replace the cover. The UPS will switch back to inverter mode.
6. The UPS will alert for ten seconds to warn that the procedure is abnormal and may damage the UPS due to uncertain utility status. The UPS will switch back to Inverter mode immediately if you turn the CAM switch back to "INV".



Troubleshooting Guide

Troubleshooting

If the UPS malfunctions during first power up, check the following:

- a. Is the input and output wiring correct?
- b. Is the input voltage of the utility within the input window of the UPS?

If problems still exist check the following error codes for possible solution. Should the problem still persist, please contact your local distributor for help.

Situation	Check Items	Solution
Red Fault LED	Check the error code shown on the LCD.	
	Er05,  , & 	Check for proper battery connection, then re-charge the batteries for 8 hours to see whether the UPS provides backup power normally; otherwise, consult your local distributor right away.
	Er06, Er10, Er12, Er28 & 	If CB3 is tripped, turn off the UPS completely and keep the CAM switch at position INV before pressing CB3. Then remove some uncritical load at the UPS output end. If there is any damage to the insulation of the AC power cord, please replace it with a new one.
	EPO	Remove the short circuit at the EPO terminal.
	Er11, Er33	Remove any objects blocking the ventilation holes.
	Er14	Check that the cooling fans on the rear panel are working normally.
	Er15	Make sure the UPS is operated normally. If it is in CVCF mode you must turn off and turn on the UPS again.
	Er16, Er27	All of the parameters except ID Number in a parallel UPS must be the same.
	Er21	Disconnect and reconnect the RJ45 connector or set a UPS with ID=1.
	Er24	When the UPS is in CVCF mode it is prohibited from having bypass input. You must turn off the UPS and bypass input and then restart the UPS.
	Other error code	Consult your local distributor for help.
UPS fails to offer battery back-up or its backup power time is shorter than calculated.		If the backup power time is still too short after 8 hours of charging please contact your local distributor for battery replacement.
UPS locks itself and cannot be turned off.		Restart UPS. Consult your local distributor for help.

Communication Software

Hardware Setup

1. Connect the male connector of the RS-232 cable to the UPS communication port.
2. Connect the female connector of the RS-232 cable to a dedicated RS-232 port of the attached computer.

Software Installation

- For local monitoring, refer to the supplied Upsilon CD.
- For remote monitoring, refer to the optional NetAgent CD that comes with Web/SNMP card.

Optional Interface Cards

Relay (Dry Contact) Card

Pin assignments of 10-pin terminal:

1	2	3	4	5	6	7	8	9	10
---	---	---	---	---	---	---	---	---	----

Pin 1: UPS on Bypass mode

Pin 2: Utility Abnormal

Pin 3: Utility Normal

Pin 4: Inverter On

Pin 5: Battery Low

Pin 6: Battery Bad or Abnormal

Pin 7: UPS Alarm

Pin 8: Common

Pin 9: Shutdown UPS positive (+) signal

Pin 10: Shutdown UPS negative (-) signal

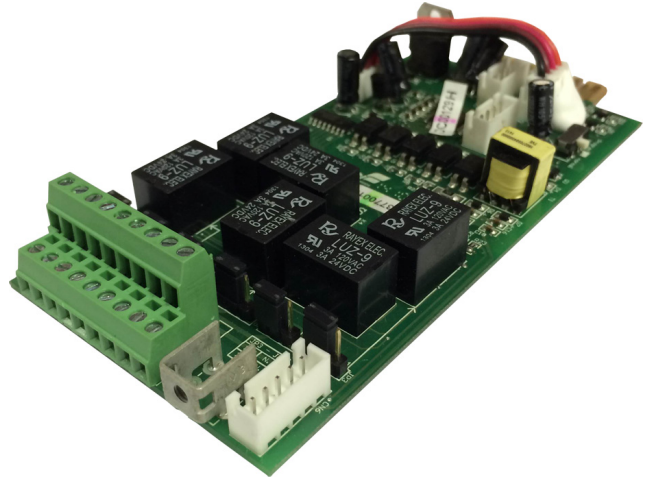

- The shutdown function will be activated after +6~+25 VDC is applied between pin 9 and pin 10 for 5 seconds.
- The capacity of each relay contact is 40 VDC/25mA.
- Installation Position: slot 2 (CHB-CN8). Relay card comes configured as slot 2 by default. If slot 1 is needed, the jumper on the relay card must be changed to CHA/slot 1.
- Flexible signal output for N.C. (Normal close) or N.O. (Normal open) contact by shorting pins 1-2 or pins 2-3 from JP1-5.
- The shutdown function will be enabled 1 minute after blackout occurs if pins 1-2 of both CN1 and CN6 are shorted. Otherwise the shutdown function can be enabled only by pins 9-10 of CN3 if pins 2-3 of both CN1 and CN6 are shorted.

SNMP Card

- Net Agent II Internal Card
- For installation please refer to the card's user manual.
- Position: slot 1 (CHA) or slot 2 (CHB)

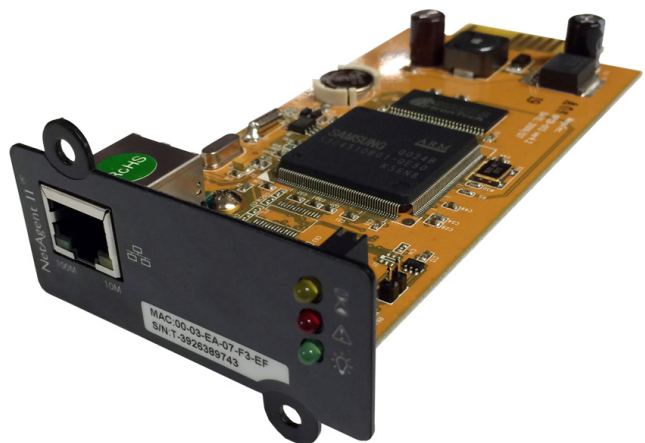

Interface Card Installation

1.



3.



2.



Replacing Batteries

To be performed by qualified personnel only

1. Unscrew the bottom of the front panel as indicated in Step 1 below.
2. Remove the front panel as indicated in Step 2.

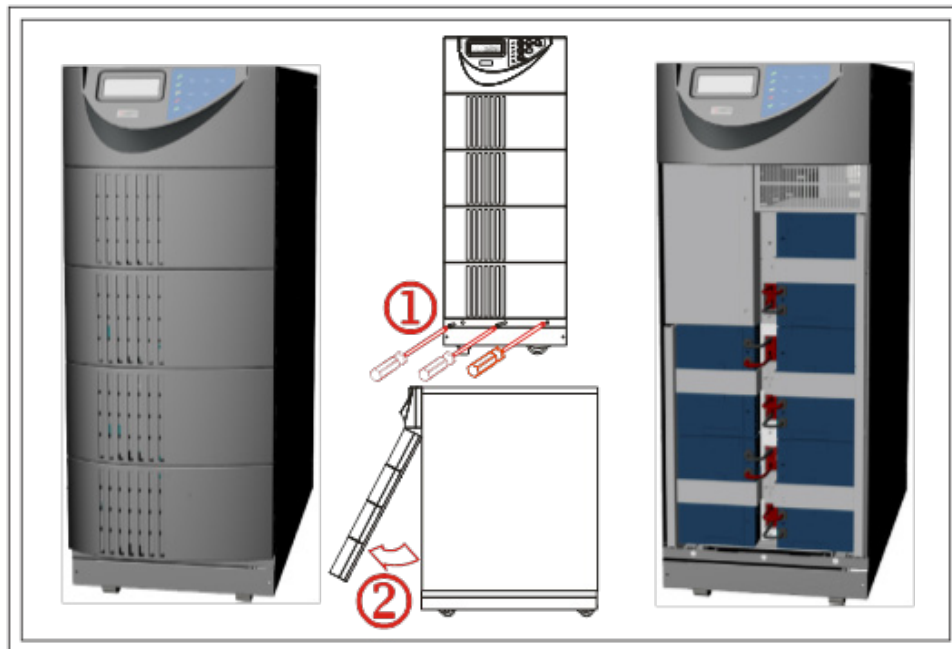

TX90-6K shown above

3. Remove the screw of the battery pack fastener as shown in Step 3.
4. Remove the fastener as shown in Step 4.
5. Unplug the hot-swappable battery connectors as shown in Step 5.

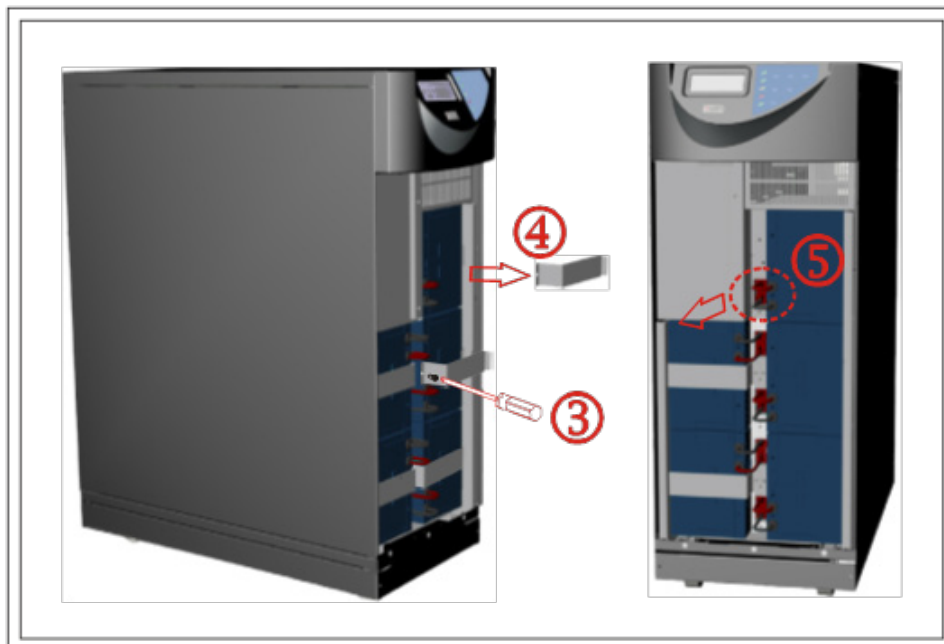

6. Rotate the battery pack handle 90 degrees as shown in Step 6.
7. Remove the battery packs from the UPS as shown in Step 7.

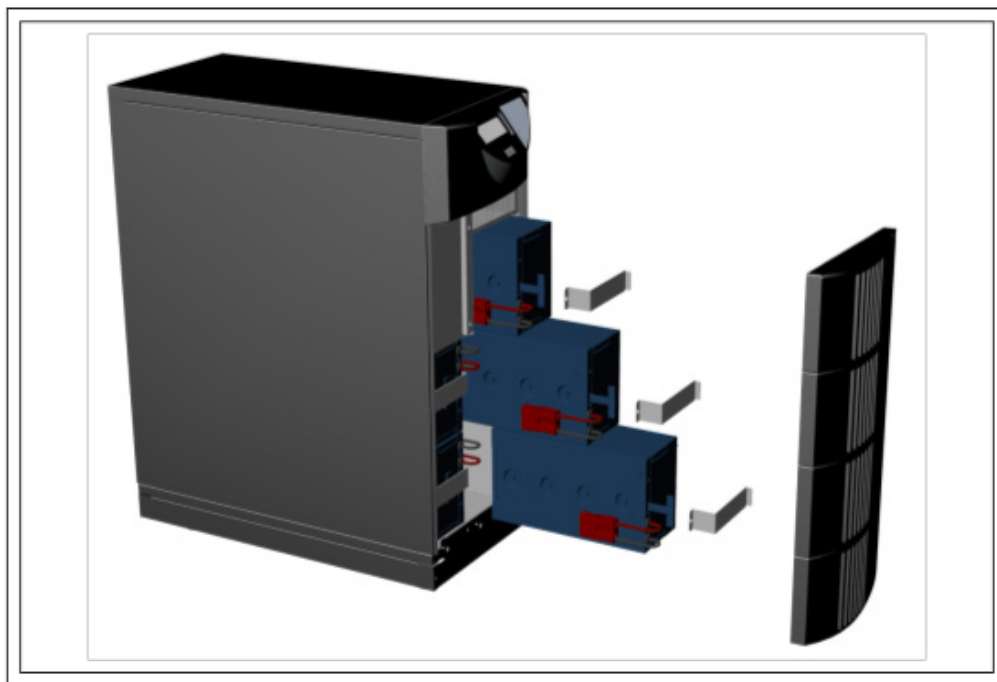
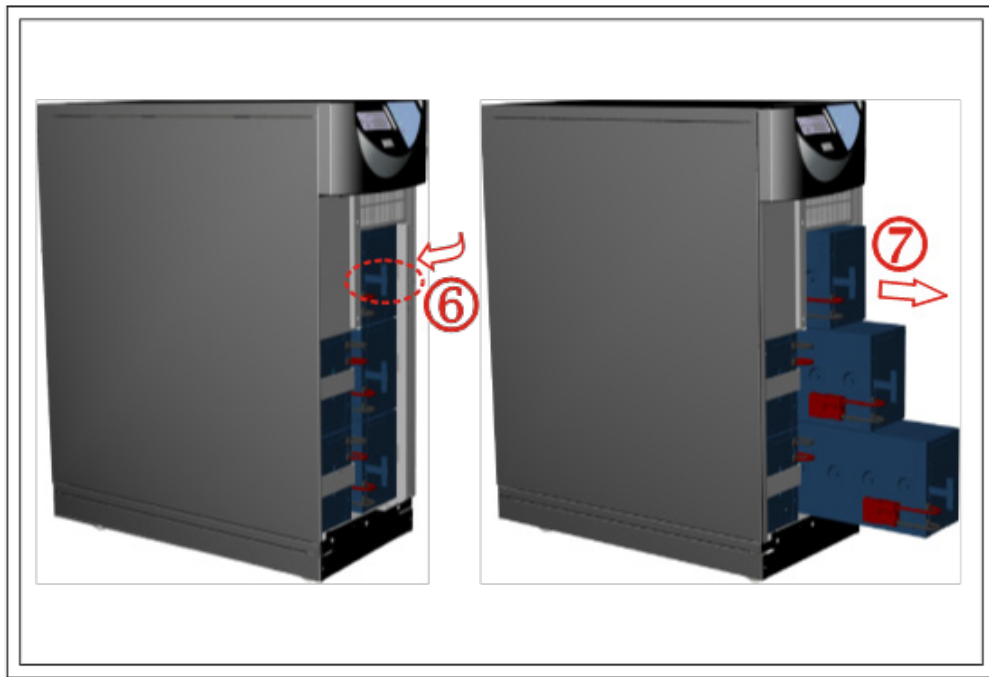

Specifications

MODEL NUMBER		TX90-6K	TX90-10K
CAPACITY	Power rating	6kVA (5.4kW)	10kVA (9kW)
INPUT	Voltage (nominal)	208VAC (200VAC, 220VAC, 230VAC, 240VAC optional)	
	Frequency	45–65Hz auto-sensing	
	Power factor	Up to 0.99 at linear load	
	Harmonic distortion	< 3% at linear load	
OUTPUT	Voltage	240/120VAC or 208/120VAC* standard (other optional voltages available)	
	Overload capacity	105%–150% for 160 sec, 2 cycles before switching to bypass	
	Efficiency	97% ECO mode, 91% online mode	
BATTERY	Battery type	Sealed, maintenance-free lead acid	
	Battery (standard models)	(20) 12V 7AH	(20) 12V 9AH
	Battery (XR models)	(20) 12V 580W	(20) 12V 580W
PHYSICAL	Input/output	Terminal blocks or optional PDU	
	Dimensions (W x D x H)	11.4 x 28.0 x 29.5 in	11.4 x 28.0 x 34.7 in
	Weight	TX90-6K–322 lbs; TX90-6KXR–332 lbs	TX90-10K–389 lbs; TX90-10KXR–399 lbs
OPTIONAL BATTERY PACKS	Battery quantity and size	EBP920–(20) 12V 9AH; EBP940–(40) 12V 9AH; EBP960–(60) 12V 9AH	
	Dimensions (W x D x H)	11.4 x 25.4 x 29.5 in	
	Weight	EBP920–204 lbs; EBP940–324 lbs; EBP960–446 lbs	
OPTIONAL PDU	Input connection	6 ft, L6–30P	Terminal blocks
	120V receptacle options	5–15/20R, L5–15R, L5–20R, L5–30R, C19	
	240V receptacle options	L6–30R, L6–20R, L6–15R, 6–15/20R, L14–30R, C19	
ENVIRONMENT	Temperature	32–104°F (0–40°C)	
	Audible noise	< 50dBA	
	Altitude	11,500 ft above sea level	
APPROVALS	UL1778, cUL, FCC Class A, RoHS		
WARRANTY	3 years electronics, 3 years battery warranty (USA and Canada)		
COMMUNICATIONS INTERFACE	RS-232, EPO, intelligent slot for optional cards (Web/SNMP, Relay/dry contact)		
INCLUDED IN BOX	User manual, RS-232 communication cable, shutdown software		
AVAILABLE OPTIONS	Output PDU, external battery charger, parallel tie/bypass, input L6–30P cord (for 6kVA only)		

*208/120VAC output consists of one leg of 120V and one leg of 88V.

Obtaining Service

If the UPS requires Service:

1. Use the TROUBLESHOOTING section in this manual to eliminate obvious causes.
2. Verify there are no circuit breakers tripped.
3. Call your dealer for assistance. If you cannot reach your dealer, or if they cannot resolve the problem, call Xtreme Power Conversion Corp Technical Support at 800.582.4524. Technical support inquiries can also be made at support@xpcc.com. Please have the following information available BEFORE calling the Technical Support Department:
 - Your name and address.
 - The serial number of the unit.
 - Where and when the unit was purchased.
 - All of the model information about your UPS.
 - Any information on the failure, including LED's that may or may not be illuminated.
 - A description of the protected equipment, including model numbers if possible.
 - A technician will ask you for the above information and, if possible, help solve your problem over the phone. In the event that the unit requires factory service, the technician will issue you a Return Material Authorization number (RMA).

If you are returning the UPS to Xtreme Power for service, please follow these procedures:

1. Pack the UPS in its original packaging. If the original packaging is no longer available, ask the Technical Support Technician about obtaining a replacement set of packaging material. It is important to pack the UPS properly in order to avoid damage in transit. Never use Styrofoam beads for a packing material.
2. Include a letter with your name, address, daytime phone number, RMA number, a copy of your original sales receipt, and a brief description of the problem.
3. Mark the RMA number on the outside of all packages. Xtreme Power cannot accept any package without the RMA number marked on the outside of the boxes.
4. Return the UPS by insured, prepaid carrier to the address provided by the Technician.
5. Refer to the Warranty statements in this manual for additional details on what is covered.

Xtreme Power Conversion Limited Warranty

Xtreme Power Conversion (XPC) Corporation warrants Xtreme Power Conversion equipment, when properly applied and operated within specified conditions, against faulty materials or workmanship for a period of **three years for TX90-Series products** from the date of purchase. XPC Corporation warrants **internal batteries for a period of three years** from the date of purchase. For equipment sites within the United States and Canada, this warranty covers repair or replacement, at the sole discretion of XPC Corporation. The customer is responsible for the costs of shipping the defective product to XPC Corporation. XPC Corporation will pay for ground shipment of the repaired or replacement product. This warranty applies only to the original purchaser.

If equipment provided by XPC Corporation is found to be **Dead-on-Arrival (DOA)**, XPC Corporation will be responsible for the costs of shipping product to and returning equipment from the customer in a timely manner as agreed to with the customer, once the customer has requested and received a **Return Material Authorization (RMA)** number. DOA equipment is defined as equipment that does not properly function according to user documentation when initially received and connected in conjunction with proper procedures as shown in the user documentation or via support provided by XPC Corporation personnel or authorized agents.

This warranty shall be void if (a) the equipment is repaired or modified by anyone other than XPC Corporation or a XPC Corporation approved third party; (b) the equipment is damaged by the customer, is improperly used or stored, is subjected to an adverse operating environment, or is operated outside the limits of its electrical specifications; or (c) the equipment has been used or stored in a manner contrary to the equipment's operating manual, intended use or other written instructions. Any technical advice furnished by XPC Corporation or a XPC Corporation authorized representative before or after delivery with regard to the use or application of Xtreme Power Conversion equipment is furnished on the basis that it represents XPC Corporations best judgment under the situation and circumstances, but it is used at the recipient's sole risk.

EXCEPT AS STATED ABOVE, XPC Corporation DISCLAIMS ALL WARRANTIES, EXPRESSED OR IMPLIED, INCLUDING WARRANTIES OF MERCHANTABILITY AND FITNESS FOR A PARTICULAR PURPOSE.

EXCEPT AS STATED ABOVE, IN NO EVENT WILL XPC Corporation BE LIABLE FOR DIRECT, INDIRECT, SPECIAL, INCIDENTAL, OR CONSEQUENTIAL DAMAGES ARISING OUT OF THE USE OF Xtreme Power Conversion EQUIPMENT, including but not limited to, any costs, lost profits or revenue, loss of equipment, loss of use of equipment, loss of software, loss of data, cost of substitutes, or claims by third parties. Purchaser's sole and exclusive remedy for breach of any warranty, expressed or implied, concerning Xtreme Power Conversion equipment, and the only obligation of XPC Corporation under this warranty, shall be the repair or replacement of defective equipment, components, or parts; or, at XPC Corporations sole discretion, refund of the purchase price or substitution of an equivalent replacement product.

Xtreme Power Conversion Load Protection Policy

THIS POLICY IS NOT A WARRANTY. REFER TO **THE XPC CORPORATION, INC. LIMITED WARRANTY** FOR INFORMATION CONCERNING THE WARRANTY FOR YOUR XPC PRODUCT. THE LIMITATIONS AND CONDITIONS CONTAINED IN THIS POLICY DO NOT AFFECT **THE TERMS OF THE XPC LIMITED WARRANTY**.

Definitions:

1. "Product" means a Standard 120, 208, or 240 Volt power protection device that is used in the United States and Canada. This policy does not include custom manufactured products.
2. "Power Disturbance" means an AC power line transient (telephone line or Local Area Network, if applicable), spike or surge.
3. "Connected Equipment" properly connected electronic equipment
4. "Fair Market Value" of damaged Connected Equipment as determined by XPC shall be the lower of (a) the average price the same or similar items are being sold for on eBay, (b) the price list of Orion Blue Book (or if such price list is no longer published, a published or announced price list reasonably selected by XPC), (c) the lowest price the same or similar items can be purchased for in the United States or (d) the total amount of all payment(s) you have or are entitled to receive from insurance, other warranties, extended warranties, a legal liability claim or from other sources or persons for the damaged Connected Equipment.
5. "Purchaser" means the person or entity that originally purchased the Product from an authorized reseller or distributor of XPC Products.

The Purchaser of this Product is protected, for the term of the XPC Limited Warranty, against certain losses caused by a Power Disturbance for properly connected electronic equipment (referred to as the "Connected Equipment") subject to certain terms and conditions provided below.

This policy applies only to the original purchaser of the Product. If the Product is transferred or sold to another person or entity, this policy is void.

Load Protection Policy Dollar and Period Limits

For purchasers that meet the qualifications and conditions set forth in this policy, XPC will provide reimbursement (cost of repair or fair market value as determined by XPC) during the period limits and up to the dollar limits stated as follows:

PRODUCT	DOLLAR LIMIT	PERIOD OF COVERAGE
XVT	25,000	Term of XPC Limited Warranty
XST	25,000	Term of XPC Limited Warranty
S70	25,000	Term of XPC Limited Warranty
XPRT 6kVA & 10kVA	50,000	Term of XPC Limited Warranty
NXRT	50,000	Term of XPC Limited Warranty
P90, P90L, P90g, P90Lg	50,000	Term of XPC Limited Warranty
T90	50,000	Term of XPC Limited Warranty
TX90, TX90i	50,000	Term of XPC Limited Warranty

This Load Protection Policy is not deemed "first dollar" coverage. XPC's obligation is reduced by any amounts that the Purchaser is entitled to recover, from other sources regarding the Connected Equipment, including, but not limited to, insurance, other warranty, extended warranty, or legal liability, regardless of whether or not the Purchaser makes a claim for recovery.

Eligibility for Coverage Under the Load Protection Policy

1. The Product must be registered on the XPC website, www.xpcc.com, within 10 days of purchase. All required information must be provided, and Purchaser should retain a copy for Purchaser's records. When registering on the website, Purchaser must list all connected equipment that is directly connected to the

- product. Only those devices registered in that manner will be covered.
2. All Connected Equipment must be UL or CSA approved.
 3. The Product must be plugged into a properly wired and grounded outlet. Use of input surge devices, extension cords, adapters, ground wires, or electrical connections not manufactured by XPC voids the XPC Load Protection Policy. No other surge protection device may be connected to the output sockets of the Product. The installation must comply with all applicable electrical and safety codes set forth pursuant to the NEC.
 4. The Product must have undeniable physical evidence of a Power Disturbance that directly and proximately caused the damage;
 5. The Connected Equipment must have been damaged by a Power Disturbance on a properly installed, grounded, and National Electric Code, ("NEC"), code-compliant 120, 208, 240 Volt AC power line in the United States or Canada, by a Power Disturbance on standard telephone land line or PBX telephone equipment line that is properly installed and connected to an RJ11 port on the Product; or by a Power Disturbance on a standard Local Area Network connection that is properly installed and connected to an RJ45 port on the Product and (d) is directly plugged into, and properly connected to, the Product in its original condition which was properly operated when a Power Disturbance passed through the Product and (i) exhausts the protection capacity of the Product or (ii) damages the Product.
 6. The Load Protection Policy does not apply if the Product has been operated in a failure mode or not in compliance with XPC operating instructions in the Product user's manual, or if the Connected Equipment has not been operated in compliance with the instructions and manuals of its manufacturer/vendor.
 7. This policy is null and void if, XPC determines, in its sole discretion, that the Product has been tampered with or altered in any way.

What is Not Covered Under the Load Protection Policy:

The following damage is not covered by this Policy:

1. Restoration of lost data and reinstallation of software.
2. Damage from a cause other than AC power-line transients, except for damage due to telephone line, Local Area Network, or CATV transients, which is covered only if the Product offers such protection.
3. DAMAGE CAUSED BY FAILURE TO PROVIDE A SUITABLE INSTALLATION ENVIRONMENT FOR THE PRODUCT (INCLUDING, BUT NOT LIMITED TO, LACK OF A PROPER SAFETY GROUND).
4. Damage caused by the use of the Product for purposes other than those for which it was designed.
5. Damage caused by accidents, or natural disasters, including but not limited to, fire, flood, and wind.
6. Damage caused by abuse, misuse, alteration, modification, or negligence.
7. Any labor costs or travel, room and board expenses associated with the repair and/or restoration of lost or damaged hardware, software or data.

EXCEPT AS EXPRESSLY PROVIDED IN THIS POLICY, XPC SHALL NOT BE LIABLE FOR ANY DAMAGES WHATSOEVER, INCLUDING, BUT NOT LIMITED TO, DIRECT, INDIRECT, SPECIAL, INCIDENTAL, CONSEQUENTIAL, OR MULTIPLE DAMAGES ARISING OUT OF THE USE OF THE PRODUCT OR DAMAGE TO THE CONNECTED EQUIPMENT, REGARDLESS OF THE LEGAL THEORY ON WHICH SUCH CLAIM IS BASED, EVEN IF ADVISED OF THE POSSIBILITY OF SUCH DAMAGE. SUCH DAMAGES INCLUDE, BUT ARE NOT LIMITED TO, LOSS OF PROFITS, LOSS OF SAVINGS OR REVENUE, LOSS OF USE OF THE PRODUCT OR THE CONNECTED EQUIPMENT OR ANY ASSOCIATED EQUIPMENT, LOSS OF SOFTWARE, COST OF CAPITAL, COST OF ANY SUBSTITUTE EQUIPMENT, FACILITIES OR SERVICES, DOWNTIME, THE CLAIMS OF THIRD PARTIES, INCLUDING CUSTOMERS, AND INJURY TO PROPERTY.

Submitting a Load Protection Policy Claim:

1. Any claim under the Load Protection Policy must be made within 10 days of the date of alleged damage to the Connected Equipment.
2. Call the XPC technical support department at 1-800- 582-4524 and obtain a Load Protection Policy Returned Material Authorization (RMA) number. Have information on all applicable insurance or other resources of recovery/payment that is available to the Purchaser and the name of the power utility supplier for the location of the Connected Equipment. XPC will forward to the Purchaser a Load Protection Policy claims form, which

must be completed and filed with XPC within 30 days.

- Mark the Load Protection Policy RMA number on the Product the Purchaser is returning.
- Pack the Product in its original packaging or similar packing materials if the original packaging has been discarded. Enclose the completed Load Protection Policy claim form and a copy of the Purchaser's original sales receipt for the Product in the box.
- Mark the RMA number clearly on the outside of the box.
- Ship the Product (one-way shipping charges paid by the Purchaser) to:

XPC Corporation
230 Yuma Street
Denver, CO 80223
Attn: LPP RMA#

3. XPC will evaluate the Product to determine its level of functionality, and will examine the Product for evidence of damage from a Power Disturbance.
 - If XPCs' evaluation provides no evidence of damage from a Power Disturbance, XPC will send to the Purchaser (i) a report summarizing the tests performed and (ii) a rejection of claim notice.
 - If the Product shows evidence of damage from a Power Disturbance, XPC will request that all Connected Equipment for which a Load Protection Policy claim has been submitted, be sent for evaluation to either XPC or an authorized service center. If it is determined that the Connected Equipment has been damaged by a Power Disturbance, XPC will, in its sole discretion, issue payment to the Purchaser for either the cost of repair of the Connected Equipment or the Fair Market Value of the damaged Connected Equipment, up to the dollar limits stated above. XPC reserves the right to require the Purchaser to transfer title and deliver the Connected Equipment to XPC if it chooses to reimburse the Purchaser for the fair market value of the Connected Equipment. XPCs' maximum liability shall be reduced to reflect all such other payments or sources of recovery, whether applied for or not.
4. If XPC issues payment to the Purchaser to have the Connected Equipment repaired, the repair must be performed at a service center that is authorized by the manufacturer of the Connected Equipment. XPC reserves the right to contact the authorized service center directly to discuss repair costs and damage to the Connected Equipment to determine if it was caused by a Power Disturbance and the right to request that the service center forward the Connected Equipment or components of the Connected Equipment to XPC for inspection
5. Unless modified in writing signed by an officer of XPC and the Purchaser, the terms of this policy are the complete and exclusive agreement between the parties, superseding all prior agreements, oral or written, and all other communications between the parties relating to the subject matter of this agreement. No employee of XPC or any other party is authorized to make any representations beyond those made in this agreement concerning the Load Protection Policy.

XPC Corporation
230 Yuma Street
Denver, CO 80223
1.800.582.4524

Appendix A: T90-EBP920, EBP940, EBP960 User Guide

Important Safety Instructions (Save These Instructions)

This manual contains important instructions that should be followed during installation and maintenance of the battery bank and batteries.

An Important Notice

- This battery bank is connected to an UPS. There will be over 240 DC voltage at the output terminals if the UPS or DC breaker is turned on.
- Do not try to repair the unit yourself, contact your local supplier or your warranty will be void.
- To eliminate any overheating of the battery bank, keep all ventilation openings free from obstruction and do not place any foreign objects on top of the battery bank. Keep the battery bank 20 cm away from the wall.
- Make sure the battery bank is installed within the proper environment as specified (0-40°C and 30-90% non-condensing humidity).
- Do not install the battery bank under direct sunlight. Your warranty will be void if the batteries fail due to overheating.
- This battery bank is designed for indoor use only.
- This battery bank is not designed for use in dusty, corrosive, and salty environment.
- The warranty for this battery bank will be void if water or other liquid is spilled or poured directly onto the battery bank. Similarly we do not warrant any damage to the battery bank if foreign objects are deliberately or accidentally inserted into the battery bank enclosure.
- The battery will discharge naturally if the system is unused for a period of time.
- It should be recharged every 2-3 months if unused. If this is not done, then the warranty will be null and void. During normal operation, the batteries will be automatically remained in charged condition.
- Servicing of batteries should be performed or supervised by trained personnel with knowledge of batteries and the required precautions
- When replacing batteries, replace with the same quantity, type & capacity.

CAUTION – Do Not Dispose of Battery or Batteries in an open fire. The Battery May Explode.

CAUTION – Do not open or mutilate the batteries. The electrolyte from the batteries is toxic and harmful to the skin and eyes.

CAUTION – Risk of Electric Shock – Battery Circuit is not isolated from AC, hazardous Voltage may exist between battery terminals and ground. Test before touching with bare hands.

CAUTION – A Battery can present a Risk of Electrical Shock and High Short Circuit Current. The Following Precaution Should be Observed When Working on Batteries:

- A. Remove watches, rings, or other metal objects.
- B. Use tools with insulated handles.
- C. Wear rubber gloves and boots.
- D. Do not lay tools or metal parts on top of batteries.
- E. Disconnect charging source prior to connecting or disconnecting battery terminals.

Introduction To The Rear Panel

Rear Panel Descriptions

T90-EBP920, EBP940, EBP960

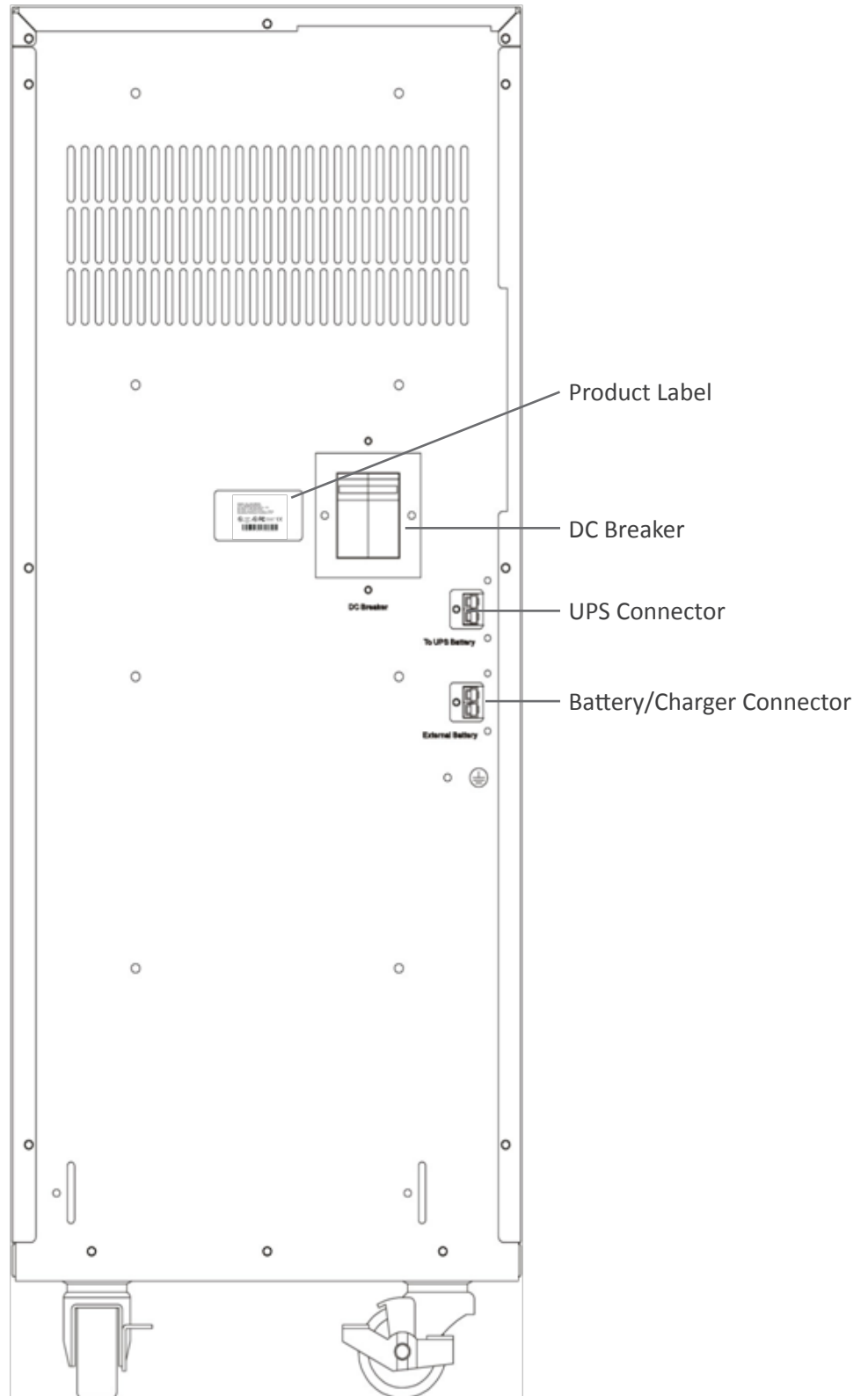

Installation And Operation

Note: The packing condition and the external outlook of the unit should be inspected carefully before installation. Retain the packing material for future use.

Unpacking

- Take the battery bank out of the PE foam.
- Remove the packing materials.
- Note: The battery bank module is approx. 120 kgs, be cautious when unpacking and lifting the unit to avoid injury.
- Standard Package includes:
 - o User's Manual
 - o DC connection cable.
 - o A pair of kits to fix DC connect cable.
 - o The casters cover kits.

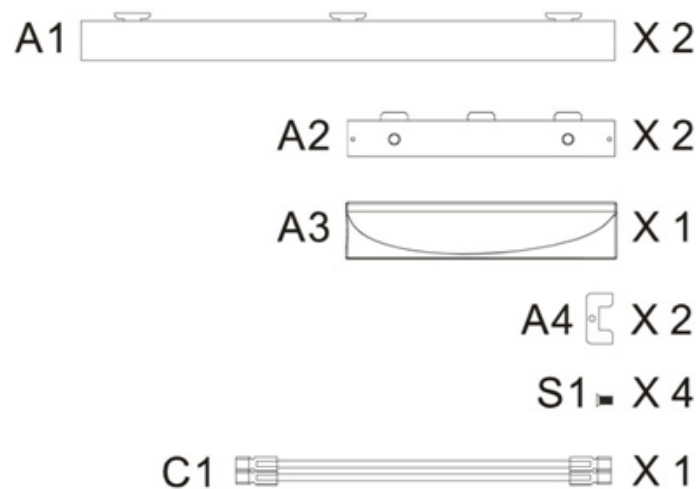

Selecting Installation Position

It is necessary to select a proper environment to install the unit, in order to minimize the possibility of damage to the battery bank and extend the life of the batteries. Please follow the instructions below:

1. Keep at least 8 inches clearance from the rear panel of the battery bank from the wall or other obstructions.
2. Do not block the air-flow to the ventilation openings of the unit.
3. Please ensure the installation site environmental conditions are in accordance with the battery bank working specifications to avoid overheat and excessive moisture.
4. Do not place the battery bank in a dusty or corrosive environment or near any flammable objects.
5. This battery bank is not designed for outdoor use.

Installation of Casters Cover

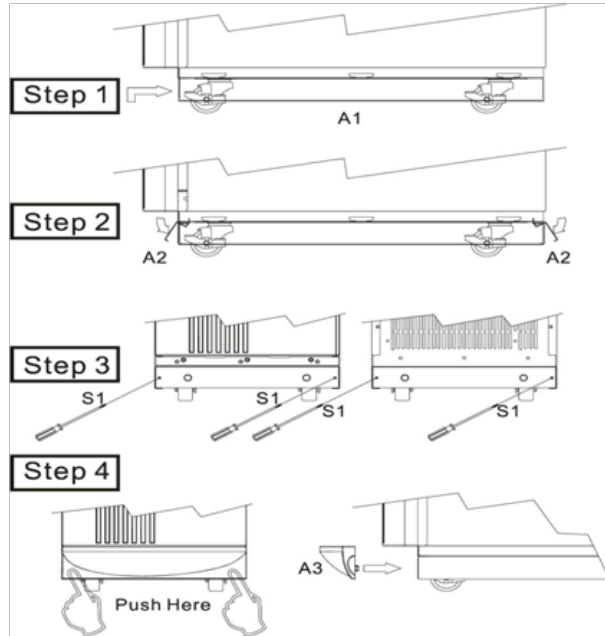

Installation Instructions

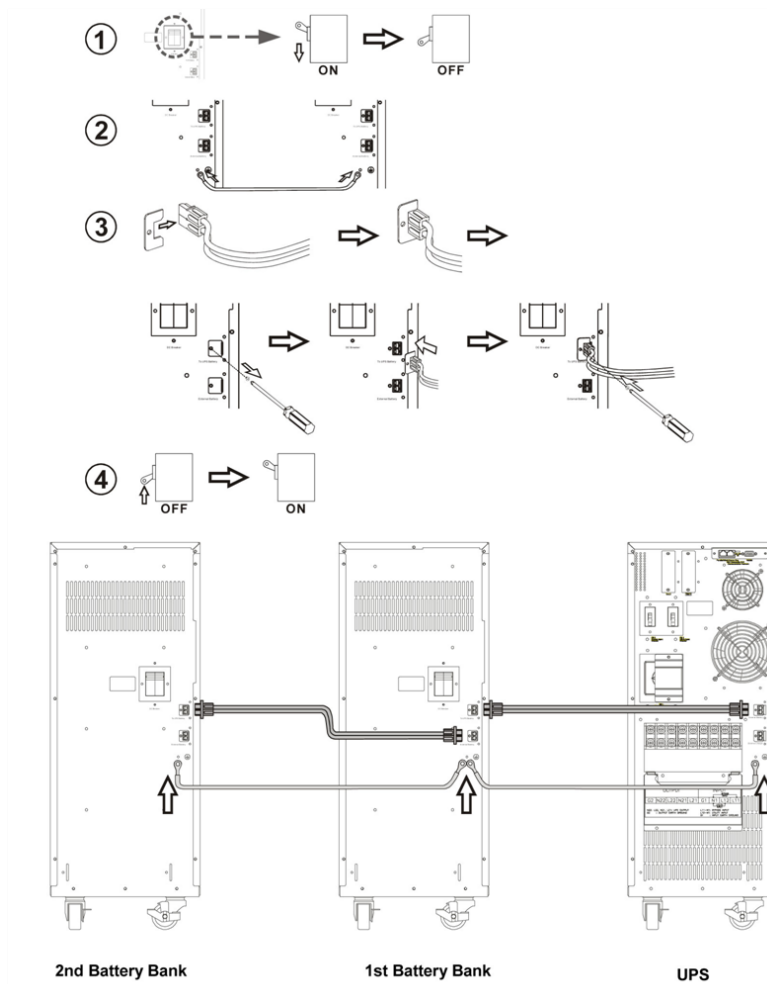

Specifications

	T90-EBP920	T90-EBP940	T90-EBP960
Dimensions (W x D x H)			
Unit	11.4 x 25.4 x 29.5 in		
Weight			
Unit	254 lbs	364 lbs	474 lbs